

EUROTATOR

Type MEK 7,5

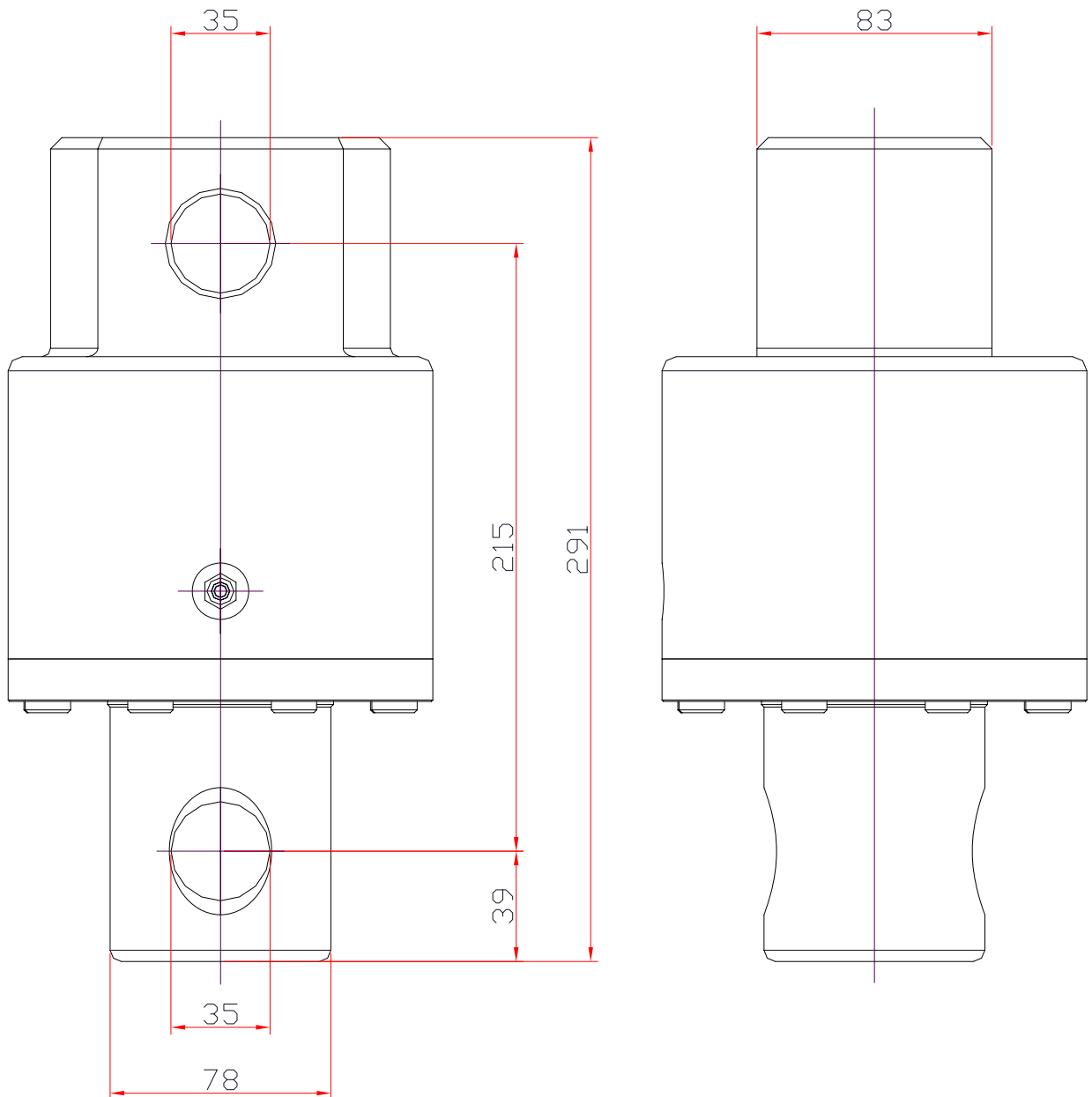

Type	Dynamische belasting kg	Statische belasting kg	Rotatie	Gewicht kg
MEK 7,5	5.000	7.500	320°	23